



# 2200 hand drawn track\_

for light and medium weight curtains



//  
STANSONS\_

# 2200

## hand drawn track

---

The design of the Stansons 2200 track makes it extremely stable and gives it an elegant look. It can be easily mounted in various ways on a wall or ceiling. A very popular track that can be used in a wide variety of situations, such as private homes, but also in office buildings and in the care sector.

- The ideal track for sheers and light or medium-weight curtains.
- Used in a wide variety of situations, such as private homes, but also in office buildings and in the care sector.
- This curtain track can be easily mounted on either a ceiling or a wall.
- Easy to bend forward or reverse, and of exceptional quality.



---

## standard colours

Natural anodised



RAL 9010 white



### features

MATERIAL:	ALUMINIUM
COLOUR:	WHITE NATURAL ANODISED
DIMENSIONS:	23 X 9 MM
WEIGHT PROFILE:	164 GR/MI
MOUNTING:	WALL OR CEILING

High quality, wear-resistant coating, highly colourfast, UV-resistant. Other RAL colours & special coatings on request.

---

# profile specifications

## Aluminium profile:

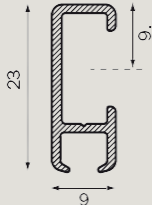

## Colours with RAL code and lengths (m)

	RAL	4	5	6	7
white	9010	•	•	•	•
natural				•	

## Mounting surface:

- wood
- masonry/concrete

## Bracket type:

- ceiling bracket
- wall bracket
- spacer bracket

## Bendings:

bending radius	bending tool
R 8 cm	1013
R 10 cm	1012
R 10 cm	1015
R > 80 cm	1018

R 10 cm

R > 80 cm

## Flow:

The Stansons Flow System keeps pleats in curtains consistent. It can be used with small and wide channel tracks and, because of the broad assortment of components, it can be integrated in hand-drawn, cord-pulled and electrically operated systems.

The Flow System can also be used with curved curtain tracks. For further information, see the Flow product data sheet.

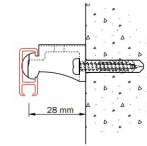

Wall mounting with 2251.

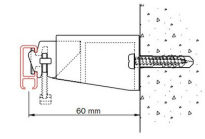

Wall mounting with 7451.



Window frame mounting with 2254

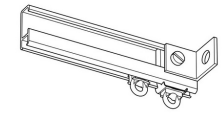

Wall mounting with 2249-N.

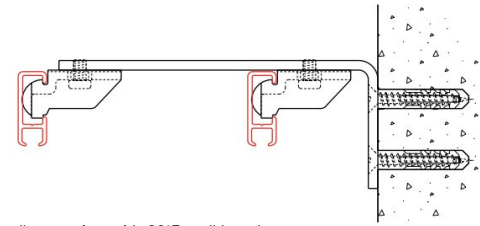

Wall mounting with 2015 wall brackets

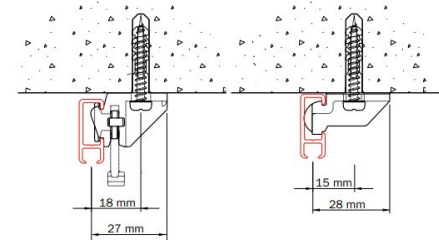

Ceiling mounting with 7450

Ceiling mounting with 2250

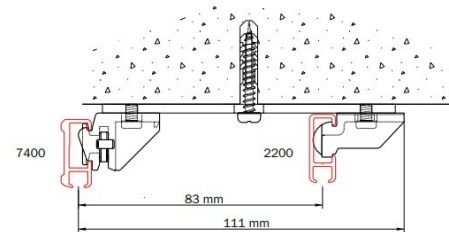

Ceiling mounting with 2216 & 7450 resp. 2250.

# mounting directions

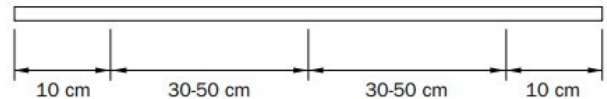

The distance between the brackets can vary depending on the following factors: the mounting surface (wood, concrete or plaster), the weight of the curtains and the curtain fabric production method, the specific application and the system usage intensity. General advice: with the curtains open, place additional brackets where the pleats bunch together. Also place additional brackets before and after bends.

## mounting directions

2 x 2200 (sheers and main draoes) combined with 7400 (valance) mounted on heavy-duty spacer brackets 2018-15

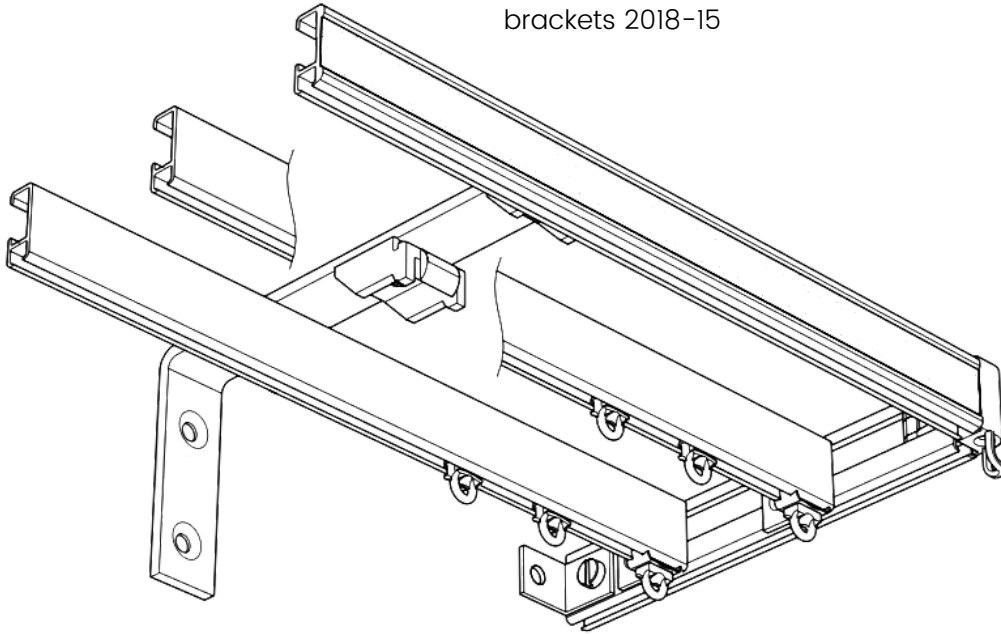

---

## specification guide

### Material:

- Aluminium EN AW-6060-T66
- Anodised in accordance with the Qualanod standard
- Powder coated in accordance with the Qualicoat standard.

