

Dim-Out Blind Systems

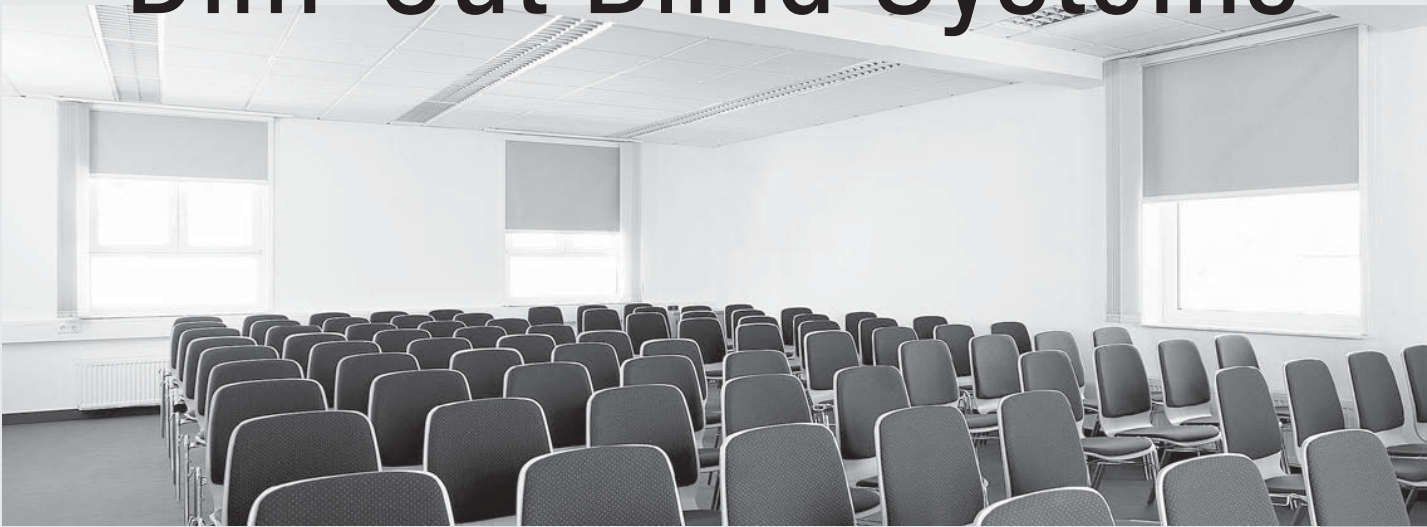



Motorised Dim-Out Blind System

Silent Gliss® 4760 Small

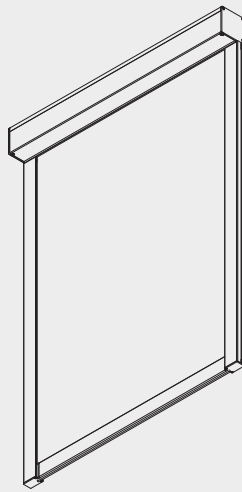

Product Information

- Technically advanced motorised dim-out blind system.
- For applications up to 1.6m wide, 1.6m high or 2.5m² with a maximum weight of 2kg.
- Easy click-in side profiles.
- Fabrics are 'zipped' into the side profiles.
- Inside or outside recess fitting.
- Supplied powder coated in black or white.
- Delivered ready-assembled, made-to-measure.
- Suitable for inclined positions up to 15° from vertical.
- Applicable with Radio Remote Control Systems and Silent Gliss Move app.
- Optional Smart motor to allow integration and control by most major home control systems

4760

Profile and Bending Information

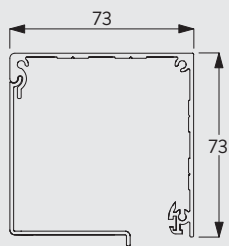

10994-5

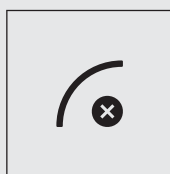

Cannot be bent

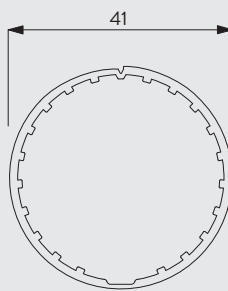

10532

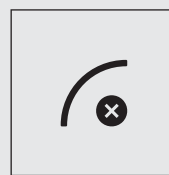

Cannot be bent

Specification text

With Series 20 Motors:

Silent Gliss 4760 Electrically Operated Dim-Out Roller Blind System with SG Series 20 motors for blinds up to 1.6m wide by 1.6m drop, max 2.5 sq.m.. Supplied made to measure and complete comprising aluminium cassette headbox 10994-5/73mm and frame finished in white or black as standard. Supplied with easy click-in side profiles 11001/11002 and fabrics are 'zipped' into the side profiles. Can be operated at up to a 15° from vertical. Integral 230v 50 Hz powered motor. Operation by mains switch (not supplied) or mains switching by third party control system or / SG 0450 remote control system (wireless controls at extra cost) All wiring to be strictly in accordance with Silent Gliss wiring diagrams. Fabric to be chosen from the Silent Gliss fabric range, Price Group 1R / 2R / 3R

With Series 40 Motors

Silent Gliss 4760 Electrically Operated Dim-Out Roller Blind System with SG Series 40 motors for blinds up to 1.6m wide by 1.6m drop, max 2.5 sqm. Supplied made to measure and complete comprising aluminium cassette headbox 10994-5/73mm and frame finished in white or black as standard. Supplied with easy click-in side profiles 11001/11002 and fabrics are 'zipped' into the side profiles. Can be operated at up to a 15° from vertical. Integral 24V DC* /100-240 V AC 50/60Hz motor. (*24V DC transformer not included). Operation by dry contact switching either from fixed switch (not supplied) or third party control system and / or Silent Gliss 9940 radio control system via integrated receiver. (9940 control components supplied at additional cost). All wiring to be strictly in accordance with Silent Gliss wiring diagrams. Fabric to be chosen from the Silent Gliss fabric range, Price Group 1R / 2R / 3R

With Smart Motors

Silent Gliss 4760 Electrically Operated Dim-Out Roller Blind System with SG Smart by Silent Gliss motors for blinds up to 1.6m wide by 1.6m drop, max 2.5 sqm. Supplied made to measure and complete comprising aluminium cassette headbox 10994-5/73mm and frame finished in white or black as standard. Supplied with easy click-in side profiles 11001/11002 and fabrics are 'zipped' into the side profiles. Can be operated at up to a 15° from vertical. Integral 24V DC powered Smart by Silent Gliss motor left / right side. Operation only via Silent Gliss Smart Gateway and associated components in conjunction with compatible third-party control systems. All wiring to be strictly in accordance with Silent Gliss wiring diagrams. Fabric to be chosen from the Silent Gliss fabric range, Price Group 1R / 2R / 3R

How To Measure

Inside fitting

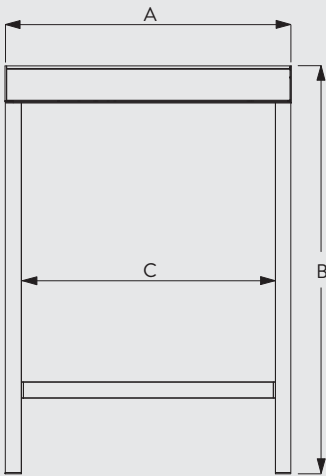

A: System width
B: System drop
C: Fabric width

Face fitting

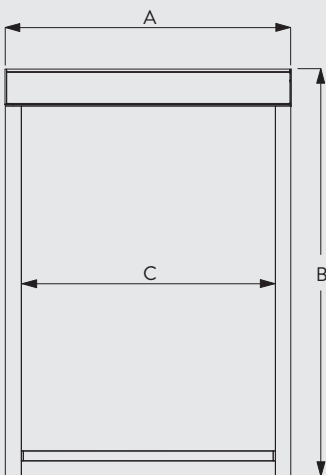

A: System width
B: System drop
C: Fabric width

4760

System Dimensions

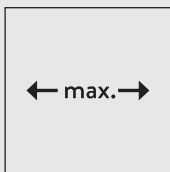

1.6m



See below:

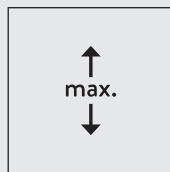

1.6m

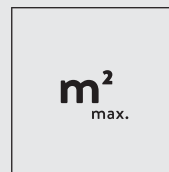

2.5m²



2kg

Minimum width:

- Series 20 / Series 40 LV / Smart - 65cm
- Series 40 mains - 82cm

System Options

Radio Remote Control System Silent Gliss 9940

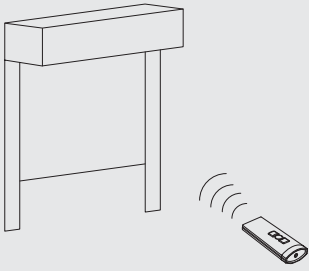

The Silent Gliss motors 10423 and 10523 feature an integrated radio receiver. Combined with the Radio Remote Control System Silent Gliss 9940, this system offers maximum comfort with minimum wiring.

The Silent Gliss motors 10422 and 10522 can be used with Radio Control System 0450 but will use an external radio receiver.

For further details, please refer to catalogue section "Motors & Controls".

Silent Gliss Move App

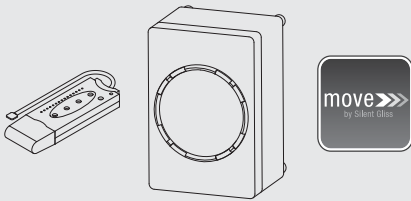

Operation of system with Silent Gliss Move app using a smartphone, tablet or desktop.

Whether at home or on the road, this reliable and intuitive app allows to program automatic opening and closing times. Furthermore, automatic sunrise and sunset time programming and groups and moods are possible.

The app is available for Android, IOS and Windows and can be downloaded in the respective app stores. Additionally, the Move Server Set Silent Gliss 9960 is required.

For further details, please refer to product group "Motors & Controls".

Smart by Silent Gliss

Silent Gliss offer Smart motor option 11251 which allows this dimout system to be integrated into, and controlled by most major home control systems.

Fitting Information

Positioning of drill holes

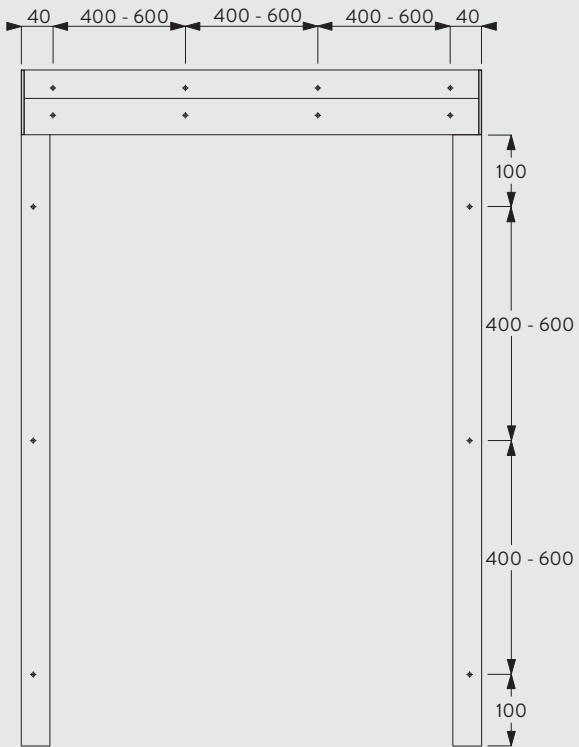

Side profiles 11001 and 11002

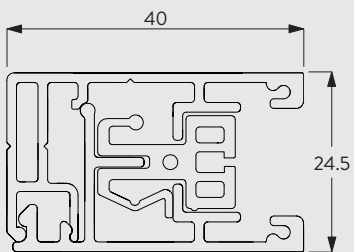

Drawing includes zip profile.

4760

Fitting Options

Ceiling fix with direct mounting

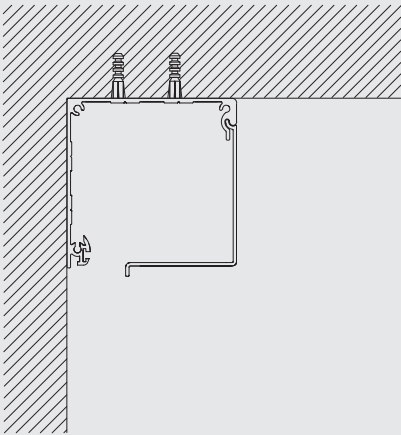

Wall fix with direct mounting

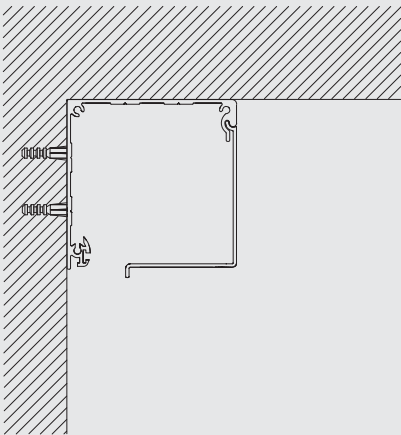

Recess fix with direct mounting

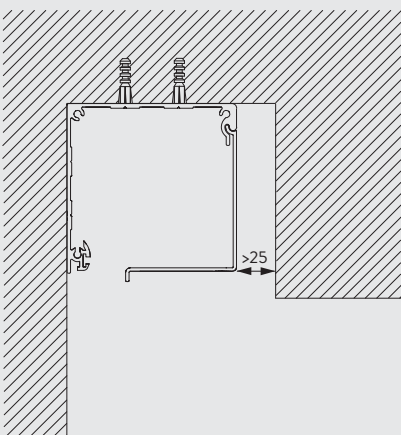

4760









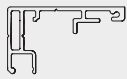
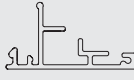

Standard Accessories

10284 O-Ring

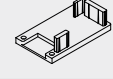









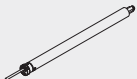





10522 Motor 20-Series, 230V



10532	Profile		10961	Zip profile	
10993	Bottom weight		11001	Side guide case	
11002	Side guide cover		11013	Clip for motor	
11024	Zip guide		11026	Cover left for side guide	
11027	Cover right for side guide		11028	Bottom weight guide left	
11029	Bottom weight guide right		11030	Bottom weight cover	
10994-5	Box case and cover, 73 mm				

Optional Accessories

10422	Motor 20-Series, 120 V		10520	Motor 20-Series, 120 V	
11241	Motor 100-240V AC, 40-Series S 3/32, radio receiver		11244	Motor 24V DC, 40-Series S 3/32, radio receiver	
11251	Smart motor 24V DC		11260	Smart controller gateway Cedia	
11261	Smart controller gateway KNX		11262	Smart expansion unit	
11263	Power supply 24V DC, 2 Ampere DIN Rail		11264	Power supply 24V DC, 3.8 Ampere DIN Rail	
11265	Power supply 24V DC, 5 Ampere DIN Rail		11266	Power supply 24V DC, 10 Ampere DIN Rail	
11281	Cabinet for 8 systems		11282	Cabinet for 24 systems	
11283	Cabinet for 56 systems		11325	Smart plug 6-pin, MC 1.5/6 ST-3.81	

4760

Useful Measures

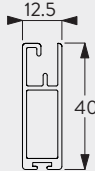
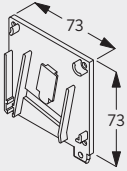
10993	Bottom weight		11004	Side cover left for box, 73 mm	
-------	---------------	---	-------	--------------------------------	---

Motor & Controls

Motor Silent Gliss 10422 (20 Series)

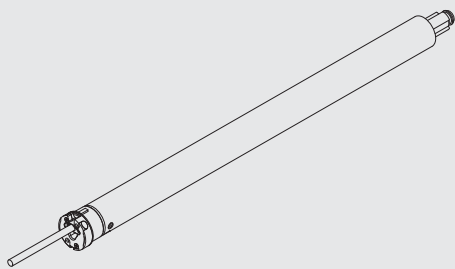

- Motor length: 545mm
- Voltage: 120 V AC
- Torque: 3 Nm
- Speed: 30 rpm
- Frequency: 50 Hz
- Power: 135 W
- Current: 0.60 A
- Thermal Overload Protection
- CE Standard
- Cable pluggable
- Max. Weight Capacity: 7.5 kg

Motor Silent Gliss 10520 (120 V)

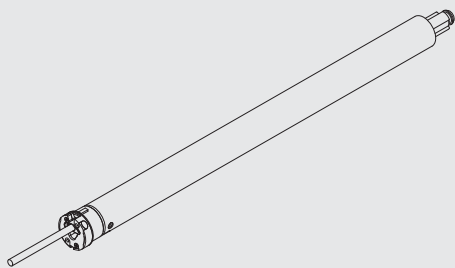

- Motor length: 545mm
- Voltage: 120 V AC
- Torque: 5 Nm
- Speed: 19 rpm
- Frequency: 60 Hz
- Power: 138 W
- Current: 1.15 A
- Thermal overload Protection
- CE Standard
- Cable pluggable
- Max. Weight Capacity: 7.5 kg

Operation via Fixed Switch

System can be operated using fixed switch

4760

Motor Silent Gliss 11241/11244 (40 Series)

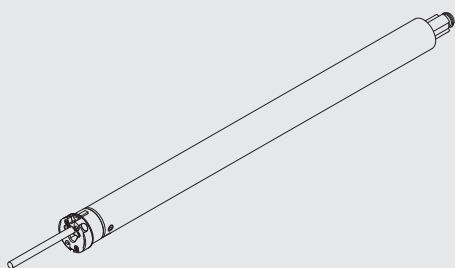

- Motor length 11241: 755mm
- Motor length 11244: 485mm
- Motor 11241: 230V supply
- Motor 11244: 24V DC supply
- Dry contact switched
- Integrated 9940 radio receiver
- Torque: 3Nm
- Speed: 32 rpm
- Power: 1.5A

Radio Remote Control System Silent Gliss 9940

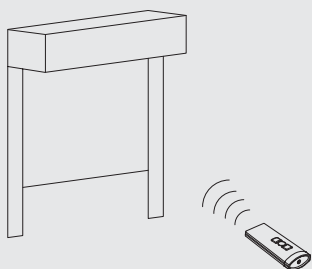

All Series 40 motors include an integrated receiver for use with Silent Gliss 9940 radio control system.

Silent Gliss Move App

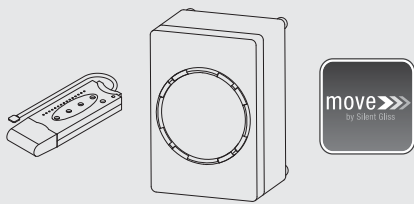

Operation of system with Silent Gliss Move app using a smartphone, tablet or desktop.

Whether at home or on the road, this reliable and intuitive app allows to program automatic opening and closing times. Furthermore, automatic sunrise and sunset time programming and groups and moods are possible.

The app is available for Android, IOS and Windows and can be downloaded in the respective app stores. Additionally, the Move Server Set Silent Gliss 9960 is required.

Motor Silent Gliss 11251 (Smart)

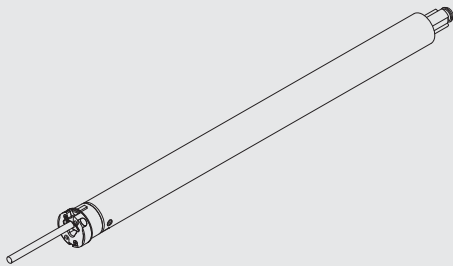

- Smart motor to allow integration and control by most major home control systems
- Max speed 32 rpm (adjustable)
- Must be used in conjunction with Silent Gliss Gateway controller and associated components.

Wiring and Connections

For other operating / wiring methods, please see section "Motors & Controls".

www.silentgliss.co.uk
www.silentglissglobal.com

Silent Gliss Ltd
Pyramid Business Park
Poorhole Lane
Broadstairs
Kent
CT10 2PT
Great Britain

Tel: +44 (0) 1843 863571
Fax: +44 (0) 1843 864503
info@silentgliss.co.uk

Silent Gliss Global Ltd
Pyramid Business Park
Poorhole Lane
Broadstairs
Kent
CT10 2PT
Great Britain

Tel: +44 (0) 1843 874250
Fax: +44 (0) 1843 874457
info@silentglissglobal.com